



OWNER'S GUIDE



S7100
SUSPENSION ELLIPTICAL™ TRAINER

Congratulations on choosing a VISION FITNESS Suspension Elliptical™ Trainer. You've taken an important step in developing and sustaining an exercise program! Your Suspension Elliptical™ Trainer is a tremendously effective tool for achieving your personal fitness goals. Regular use of your Suspension Elliptical™ Trainer can improve the quality of your life in so many ways...

Here are just a few of the health benefits of aerobic exercise:

- Weight Loss
- A Healthier Heart
- Improved Muscle Tone
- Increased Daily Energy Levels
- Reduced Stress
- Help in Countering Anxiety and Depression
- An Improved Self Image

The key to reaping these benefits is to develop an exercise habit. Your new Suspension Elliptical™ Trainer will help eliminate the obstacles that prevent you from getting in your exercise time. Neither bad weather or darkness will interfere with your workout when you have your Suspension Elliptical™ Trainer in the comfort of your home. This Owner's Guide provides you with basic information on starting an exercise program. A more complete knowledge of your new Suspension Elliptical™ Trainer will assist you in realizing your goal of a healthy lifestyle.

Please contact your authorized VISION FITNESS retailer should service be required. If a question or problem arises which cannot be handled by your VISION FITNESS retailer, please contact us:

VISION FITNESS
 Ph: 1.800.335.4348
www.visionfitness.com

Table of Contents.....

S7100

SAFETY INSTRUCTIONS.....	4
POWER REQUIREMENTS.....	5
ASSEMBLY & MOVING.....	6
PLACEMENT, STABILIZING, & POWER.....	7
CONTACT HEART RATE.....	8
VARIABLE INCLINE.....	9

CONSOLE

DISPLAY CONSOLE OVERVIEW.....	10
CONSOLE DISPLAY DESCRIPTIONS.....	11
CONSOLE PROGRAMS.....	14
USING THE PROGRAMS.....	20
USING THE SPRINT 8 PROGRAM.....	22
USING THE CUSTOM PROGRAMS.....	23
USING HEART RATE TRAINING.....	24
USING THE HEART RATE CHEST STRAP.....	25
ENGINEERING MODE.....	26

GENERAL

PREVENTATIVE MAINTENANCE.....	27
TROUBLESHOOTING.....	28
TROUBLESHOOTING HEART RATE CHEST STRAP.....	29
HOME WARRANTY.....	30
DEVELOPING A FITNESS PROGRAM...	32
EXERCISE GUIDELINES.....	33
TARGET HEART RATE.....	34
BALANCED FITNESS.....	35



PREMIER

DUAL-ACTION
HANDLEBARS

CONSOLE



FOOT PAD

FRONT FOOT &
TRANSPORT WHEELS

S7100
SUSPENSION ELLIPTICAL TRAINER

IMPORTANT SAFETY INSTRUCTIONS

SAVE THESE INSTRUCTIONS

When using an electrical product, basic precautions should always be followed, including the following:

Read all instructions before using this exercise product.

WARNING! To reduce the risk of burns, fire, electrical shock or injury to persons:

- Use this exercise product for its intended use as described in this Owner's Guide. Only use attachments recommended by the manufacturer.
- Never drop or insert any object into any opening.
- Do not remove the Suspension Elliptical™ Trainer sidecovers. Service should be performed only by an authorized VISION FITNESS retailer.
- Never operate this Suspension Elliptical™ Trainer if it has a damaged cord or plug, if it is not working properly, or if it has been damaged or immersed in water. Please contact your authorized VISION FITNESS retailer for service.
- Keep the cord away from heated surfaces.
- Do not use the Suspension Elliptical™ Trainer in any location that is not temperature controlled, such as, but not limited to garages, porches, pool rooms, bathrooms, car ports or outdoors. Failure to comply may void the warranty.
- To disconnect, turn the switch on the front of the unit to the OFF position, then remove plug from outlet.
- Only use the power cord provided with your VISION FITNESS Suspension Elliptical™ Trainer.
- Never place the power cord under carpeting or place any object on top of the power cord that may pinch and damage it.
- Unplug your Suspension Elliptical™ Trainer when not in use, before cleaning, and before moving it.
- This Suspension Elliptical™ Trainer should not be used by persons weighing more than 300 pounds. Failure to comply will void the warranty.
- Unplug Suspension Elliptical™ Trainer before moving or cleaning it. To clean, wipe surfaces down with soap and slightly damp cloth only; never use solvents. (See MAINTENANCE)
- Keep the topside of the foot support clean and dry.
- Do not turn pedals by hand.
- This Suspension Elliptical™ Trainer is intended for in-home use only. Do not use this Suspension Elliptical™ Trainer in any commercial, rental, school or institutional setting. Failure to comply will void the warranty.
- Disconnect all power before servicing the equipment.

IMPORTANT – The heart rate function on this product is not a medical device. While heart rate grips can provide a relative estimation of your actual heart rate, they should not be relied on when accurate readings are necessary. Some people, including those in a cardiac rehab program, may benefit from using an alternate heart rate monitoring system like a chest or wrist strap. Various factors, including movement of the user, may affect the accuracy of your heart rate reading. The heart rate reading is intended only as an exercise aid in determining heart rate trends in general. Please consult your physician.

CHILDREN

- At NO time should pets or children under the age of 13 be closer to the Suspension Elliptical™ Trainer than 10 feet.
- At NO time should children under the age of 13 use the Suspension Elliptical™ Trainer.
- Children over the age of 13 should not use the Suspension Elliptical™ Trainer without adult supervision.

OTHER SAFETY TIPS FOR YOUR VISION FITNESS SUSPENSION ELLIPTICAL TRAINER

CAUTION! If you experience chest pains, nausea, dizziness or shortness of breath, stop exercising immediately and consult your physician before continuing.

- Do not wear loose clothing that might catch on any part of the Suspension Elliptical™ Trainer.
- Read this Owner's Guide before operating this Suspension Elliptical™ Trainer.

POWER REQUIREMENTS

Only use with the original plug as supplied. An improper connection of the equipment grounding conductor can result in a risk of an electrical shock. Do not modify the plug that was provided with this product. If this plug does not fit into your outlet, have a qualified electrician install the proper outlet. Adapters, extension cords and surge protectors should not be used with this product.

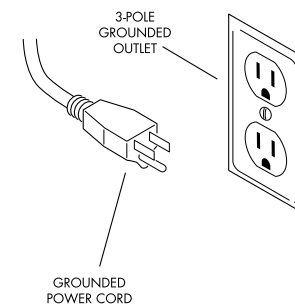

ASSEMBLY

It is recommended, when possible, that an authorized VISION FITNESS retailer assemble your Suspension Elliptical™ Trainer. If you have elected to assemble this product yourself, for your safety, please read and follow each of the steps in the enclosed assembly instructions. If you have any questions regarding any component or function of your Suspension Elliptical™ Trainer, contact your retailer.

MOVING

Your VISION FITNESS Suspension Elliptical™ Trainer has transport wheels included for ease of mobility. To move, firmly grasp the rear of the frame assembly. Carefully lift and roll on the transport wheels.

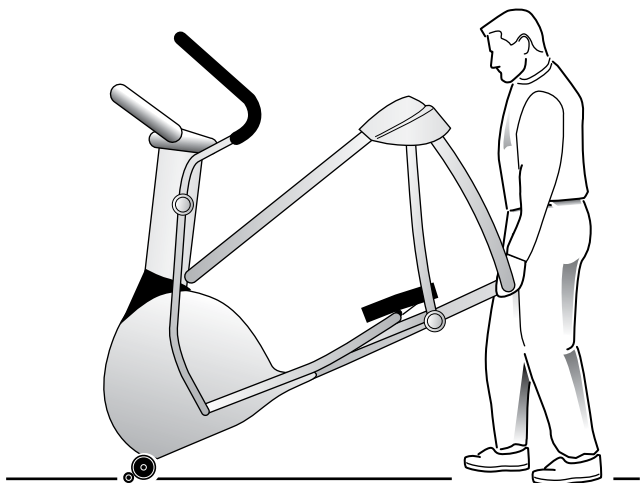

CAUTION: Our Suspension Elliptical™ Trainers are well-built and heavy, weighing up to 300 pounds! Use care and additional help if necessary.

PLACEMENT IN YOUR HOME

Please follow the safety instructions to place the Suspension Elliptical™ Trainer in the location where it will best be used. It is important that you place your Suspension Elliptical™ Trainer in a comfortable and inviting room. Avoid putting your Suspension Elliptical™ Trainer in an unfinished basement or undesirable setting. Exercise adherence will be easier to achieve only if you exercise in an attractive setting.

STABILIZING THE SUSPENSION ELLIPTICAL TRAINER

After positioning the Suspension Elliptical™ Trainer in its intended location, check the unit's stability. Rocking or wobbling indicates that your Suspension Elliptical™ Trainer needs to be leveled. Determine which leveler is not resting completely on the floor. Loosen the nut at the base of the leveler to allow the leveler to rotate. Now rotate the leveler to the left or right until the Suspension Elliptical™ Trainer is stable. Lock the adjustment by tightening the nut against the support tube.

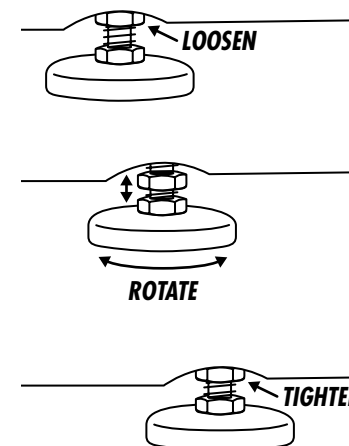

TURNING THE UNIT ON AND OFF

Use the power switch on the front of the unit to turn the machine ON and OFF. It is recommended to turn the machine off when not in use.

NOTE: You can also turn the power off at the console.

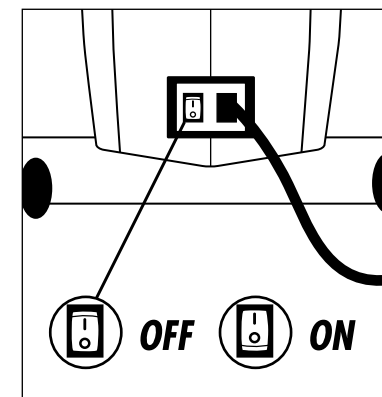

CONTACT HEART RATE

HAND PULSE HEART RATE SENSORS

The Contact Hand Pulse Sensors are included on each product to monitor your heart rate. To use, grasp both of the sensors with a comfortable grip during your workout. The console will display your heart rate. It may take the system a few seconds to zero in on your actual heart rate. Most people have a grip that is conductive enough to transmit a good signal. However, some people have erratic heart rates or improper body chemistry to transmit a good signal through the touch sensitive hand pulse grips.

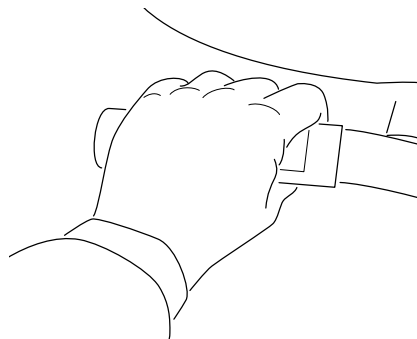

VARIABLE INCLINE

Press the INCLINE UP or DOWN arrows to adjust the incline from level 1 to 20. This incline setting represents a range of motion.

Incline changes are not immediate. They will take time to get to the target incline angle.

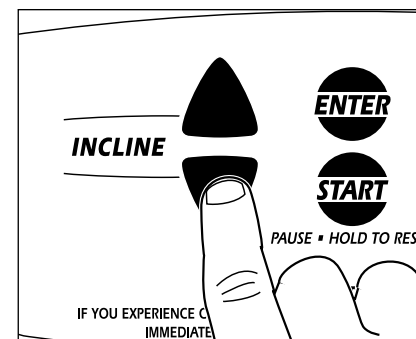

DISPLAY CONSOLE OVERVIEW

The computerized display allows the user to select a workout that meets their desired fitness goals. It also allows the user to monitor the progress and feedback of each workout so they can track improvements in overall fitness over time.

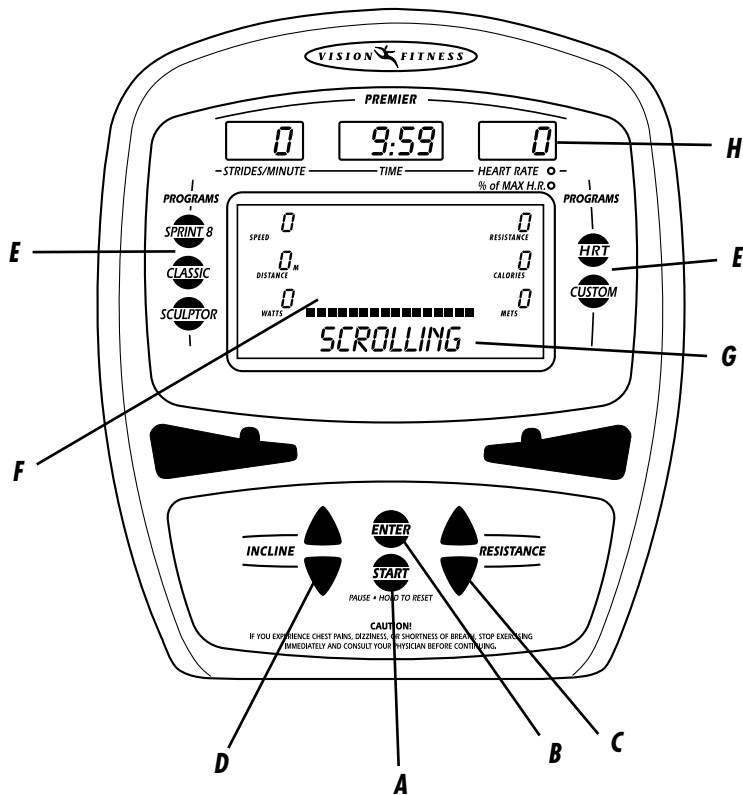

CONSOLE DISPLAY DESCRIPTIONS

A. START/PAUSE/HOLD TO RESET

Press the START key to begin a MANUAL workout immediately without having to set individual information. When the program begins, you have the ability to adjust incline and resistance levels with the ARROW keys. Feedback information will be calculated using default settings.

PAUSE: If you need to PAUSE your program during a workout, pressing the START key will PAUSE your program for five minutes. Pressing START will return you to your workout.

RESET: If you need to RESET the console during your workout, you can do so by holding down the START key for three seconds or until the display resets.

B. ENTER/HOLD TO CHANGE FEEDBACK DISPLAY

This key is used after entering each piece of information in setup such as Age, Weight, or Level.

SCAN: When exercising in a program, pressing the ENTER key will allow you to change what is displayed in the Heart Rate Feedback window. Press ENTER to switch between Heart Rate and % Max. Heart Rate. If you hold down the ENTER key for three seconds during your workout, the SCAN function will automatically alternate feedback display views.

C. RESISTANCE ARROW KEYS

These keys are used to change values in setup mode prior to your workout. During your workout, they are used to change resistance levels. In HRT® programs, they are used to change your target heart rate.

D. INCLINE ARROW KEYS

These keys can be used to change values in setup mode prior to your workout. During your workout, they are used to change incline levels.

E. PROGRAM KEYS

These keys provide quick access to your favorite workouts. There is no need to scroll through the programs to find the one you want. Simply press the program key you want and you begin user setup.

CHANGE ON THE FLY: You can change your program "on the fly" by simply pressing another program key. The SPRINT 8™, SCULPTOR, and CUSTOM USER programs can not be changed to or from "on the fly".

CONSOLE DISPLAY DESCRIPTIONS (continued)

F. PROFILE DISPLAY

The LCD display screen provides a profile of your workout, this includes the workout segments you are about to complete as well as the ones you have already completed, and the level of resistance for each segment.

G. MESSAGE/SCROLLING TEXT BAR

The LCD display has an alpha-numeric scrolling text bar which provides step-by-step instructions in the setup mode, and instructions, feedback or motivational messages during your workout and at the end of your workout.

FEEDBACK DISPLAY: During your workout the LCD displays exercise feedback about your workout, including:

DISTANCE: the total distance traveled in miles or kilometers since the start of your workout.

WATTS: measurement of workload; one watt is equal to six kilogram-meters per minute.

RESISTANCE: the current resistance level of your workout.

INCLINE: the current incline level of your workout. There are 20 levels that represent 19% grade change.

CALORIES: an estimate of calories burned since the beginning of the workout.

METS: a measurement of oxygen consumption; one MET equals the approximate amount of oxygen consumed per minute by a person at rest.

H. FEEDBACK WINDOWS: During your workout these three windows display exercise feedback about your workout.

TIME: this window provides feedback on the time elapsed or the time remaining in your workout.

STRIDES PER MINUTE: this window provides feedback on the stride rate per minute.

HEART RATE/% MAX HEART RATE: this window provides feedback on your current Heart Rate and the percent of your predicted maximum heart rate (% Max HR).

ON/OFF SWITCH Turn your console off if you will not use it for an extended period of time.

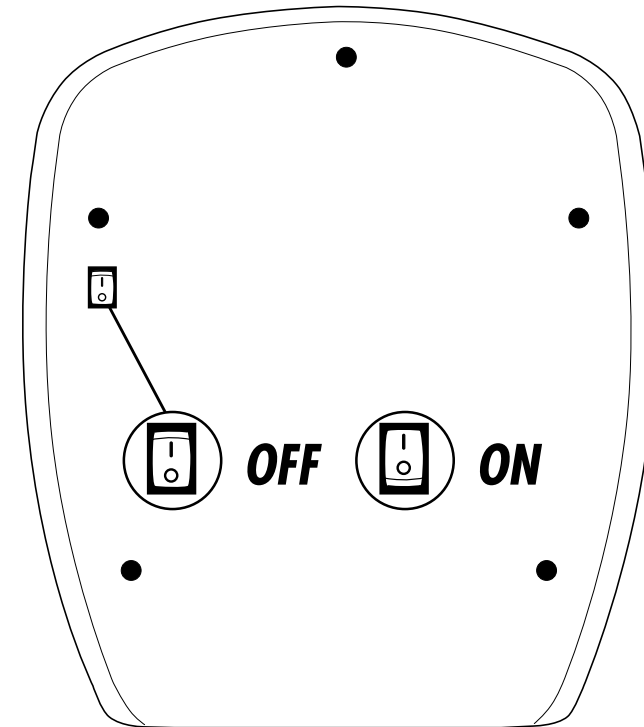

CONSOLE PROGRAMS

WORKOUT OVERVIEW

QUICK START

Simply press START and you will skip the setup of specific workouts and begin exercising at a constant level (manual) workout. The resistance and incline levels do not change automatically, but you can adjust the resistance or incline with the arrows as you choose.

NOTE: Because you did not go through setup mode, the computer will use default values to calculate your feedback information.

SPRINT 8™ PROGRAM

SPRINT 8™ is an anaerobically-based interval program. It is effective in recruiting fast twitch muscle fibers and improving athletic performance.

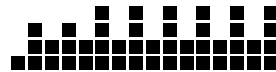

CLASSIC PROGRAMS

MANUAL is a workout in which the resistance or incline levels do not change unless you change them.



INTERVALS is an efficient workout that strengthens your cardiovascular system by alternating work intervals with recovery intervals. Be sure to challenge yourself with intense work intervals.



FAT BURN is a program intended to target your stored body fat. This program is generally used at a slightly lower intensity, but runs for longer durations than other programs (30 to 60 minutes is recommended).

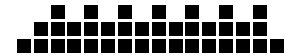

RANDOM is a program for users who enjoy variety in their daily workout routine. When this program is selected the computer will randomly select resistance and incline levels for each segment of the workout based on the resistance level that the user chose in set-up mode.

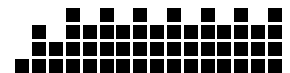

WATTS is a program that lets the user exercise at a set work level. As you increase your strides per minute, your resistance will decrease; if you decrease your strides per minute, your resistance will increase.

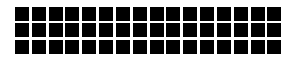

SCULPTOR PROGRAMS – 25 minutes to SCULPT a new YOU

The SCULPTOR programs were designed to work independently as individual workouts or collectively as a weekly exercise routine promoting weight loss and development of a toned upper and lower body in only 25 minutes a day. The different sculptor programs are so effective because they alternate cardiovascular exercise intervals with SETS of higher intensity exercise that use resistance, incline, and direction changes to target specific muscle groups stimulating strength gains, increased muscle tone, and greater calorie expenditures. This gives you the ability to create a customized exercise routine that utilizes one or a combination of these programs three to five times a week to SCULPT a new you in only 25 minutes a day.

GLUTE BURN

The GLUTE BURN program contains eight 45 second sets of increased muscular effort. These sets focus effort on the hamstring and gluteals by utilizing muscle targeting incline angles and increased resistance. This unique program design results in a workout that is not only great cardiovascular and calorie burning exercise but also allows users to add strength and muscle tone to their hamstring and gluteal regions.

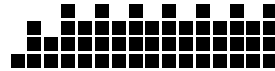

CALF TONER

The CALF TONER program was created to do just that, tone your calf and lower leg while burning calories necessary to give you slimmer legs. This program utilizes eight 45 second SETS of increased resistance along with direction changes to place emphasis on the muscles in the lower legs. Standing on the balls of the feet during these sets is an effective way to further recruit these lower leg muscles.

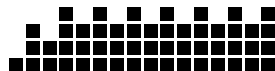

QUAD TONER

The QUAD TONER program was designed to target the Quadriceps muscle group, increasing strength and muscle tone through eight 45 second sets of increased resistance and incline changes while simultaneously burning calories and working the cardiovascular system. This combination of strength and aerobic exercise will lead to more eye-catching and defined legs.

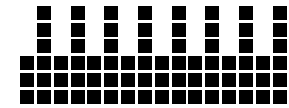

TOTAL BODY

The TOTAL BODY program has eight 45 seconds sets that use changes in body position, resistance, and incline to target all the muscle groups in your body. This program is great for overall strength and conditioning.



HRT PROGRAMS

TARGET HRT

The TARGET HRT program is designed to maintain your heart rate at 70% of your predicted maximum heart rate. It is intended to improve efficiency and endurance of your cardiovascular system by working your heart, lungs and circulatory systems. This is a great workout for anyone, but beginners may want to start lower and build their way up to 70% of their predicted maximum heart rate.

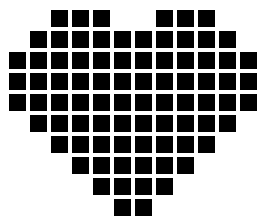

HRT HILL

The HRT HILL program uses four different Target Heart Rates to build cardiovascular strength and endurance. The resistance will adjust until your heart rate reaches the Target Heart Rate for four separate hills. The hills will be set at 65%, 70%, 75%, and 80% of your predicted maximum heart rate. The program will keep you at each heart rate level for one minute from the time the Target Heart Rate is reached. The program will repeat the series of hills until the workout time is complete.

HRT INTERVAL

The HRT INTERVAL program is designed to increase aerobic endurance and your overall fitness level, increase endurance of muscle fibers, and increase the amount of calories burned in your exercise session. This program consists of alternating effort and recovery intervals. The Target Heart Rate for your effort interval will be 80% of your predicted maximum heart rate, while the Target Heart Rate for your recovery intervals will be 70% of your predicted maximum heart rate. The two-minute effort interval begins when you reach your Target Heart Rate for that particular interval. The recovery interval duration depends on the amount of time it takes to get to your recovery heart rate.

ALL HRT PROGRAMS

During the workout, the user will grasp the hand pulse sensors or wear the telemetric chest strap to send their heart rate signal to a receiver in the console. The console will continuously monitor the heart rate, adjusting the resistance level to keep your heart rate within several beats of your Target Heart Rate. By using the SCAN key, the heart rate feedback window conveniently displays your Heart Rate and % of Max. Heart Rate to keep you informed about your current heart rate. Each program will begin with a two-minute warm-up. When the workout time has been completed, the console will begin a five-minute cool-down. The user will be responsible for adjusting resistance to meet their needs during the warm-up and cool-down.

ADJUSTING TARGET HEART RATE

While exercising in one of the HRT® programs, you may decide the Target Heart Rate needs to be adjusted. To adjust your Target Heart Rate, use the UP ▲ arrow or DOWN ▼ arrow. Press ENTER to select.

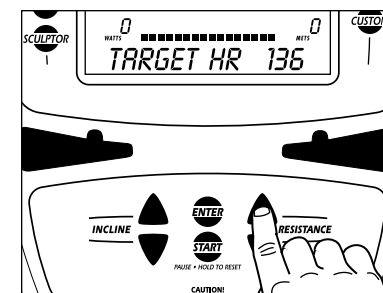

CUSTOM USER PROGRAMS

CUSTOM USER 1 – 5

The five CUSTOM USER programs allow five separate workouts to be completed, saved, and then stored for future use. As you complete your workout, the CUSTOM USER program will save your resistance and incline changes throughout the program. Your settings will be saved to provide an identical program that can be selected for your next exercise session.

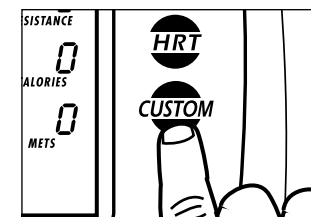

USING THE PROGRAMS

SELECTING QUICK START

The easiest way to begin exercising is to simply press the START key. You will begin exercising at a MANUAL program in which you can change the resistance and incline levels to meet your goals. Current default settings will be used to determine exercise feedback.

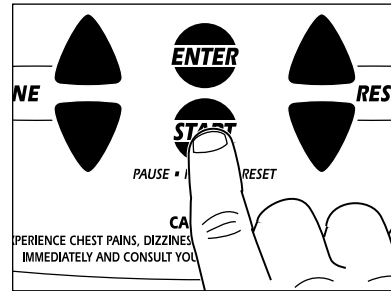

SELECTING A PROGRAM

There are five program keys. SPRINT 8 is a stand alone key and the other program keys have multiple programs. To view the program option within each key, press the key multiple times, or use the arrow keys after your initial press. Press ENTER to select.

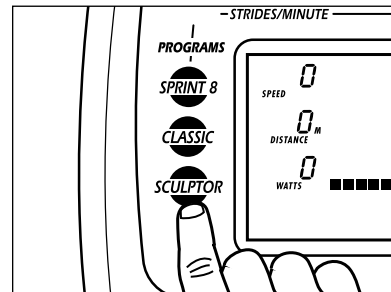

ENTERING AGE

When prompted by the message center to enter your age, use the UP ▲ arrow or DOWN ▼ arrow to adjust displayed age to the correct value. This information is necessary for the HRT® programs and will affect your “% Max. Heart Rate” feedback.

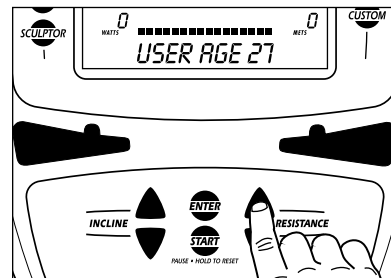

ENTERING TIME

When prompted by the message center to enter a time, use the UP ▲ arrow and DOWN ▼ arrow to adjust the displayed exercise time to a desired value.

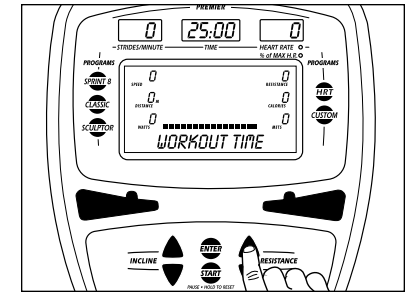

ENTERING RESISTANCE LEVEL

When prompted by the message center to enter resistance level, use the UP ▲ arrow and DOWN ▼ arrow to adjust the displayed resistance level. There are 20 levels of resistance to choose from in each program. The resistance level varies by program.

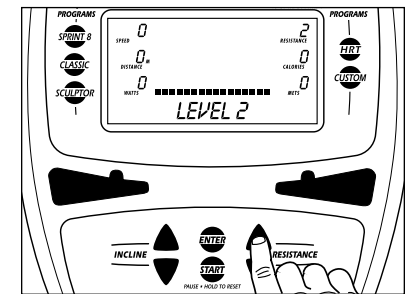

The WATTS program will ask you to set the desired WATT level instead of resistance levels. The WATT level will range from 40 to 250 in increments of five.

The TARGET HRT, HRT HILL, and HRT INTERVAL programs will set your Target Heart Rate in the place of resistance level. The console will display your Target Heart Rate and give you the opportunity to adjust this value if you wish.

ENTERING WEIGHT

When prompted by the message center to enter weight, use the UP ▲ arrow and DOWN ▼ arrow to adjust the displayed weight to equal your current body weight. This information is necessary to give accurate exercise feedback for calorie and MET calculations.

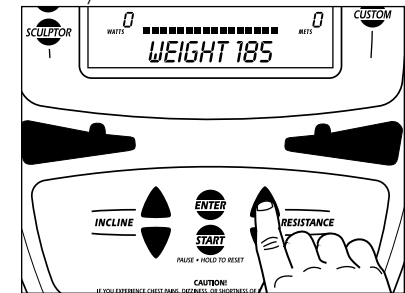

STARTING

Press START to begin your workout.

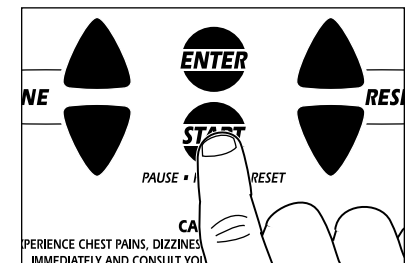

USING THE SPRINT 8 PROGRAM

The Sprint 8 program is an anaerobic interval program designed to build muscle, improve speed, and naturally increase the release of Human Growth Hormone (HGH) in your body. Producing HGH through exercise and a proper diet has been shown as an effective way to burn fat and build lean muscle mass according to Phil Campbell, author of *Ready, Set, Go! Synergy Fitness*. Please go to Mr. Campbell's website www.readysetgofitness.com for more details about this radical new approach to fitness.

The SPRINT 8 program features intense sprint intervals followed by recovery intervals. The program includes the following phases:

1. **WARM-UP** should gradually increase your heart rate and increase respiration and blood flow to working muscles. The warm-up is controlled by the user to meet your specific needs.
2. **INTERVAL TRAINING** starts immediately after the warm-up with a 30-second sprint interval. Seven recovery intervals of one minute and 30 seconds will alternate with the eight 30-second sprint intervals. The message display will prompt you to increase your strides per minute (SPM) during the sprint interval and decrease SPM during the recovery interval. A difference of 40 to 60 SPM between sprint interval and recovery interval is recommended.
3. **COOL-DOWN** helps return your body's systems to resting levels. Less demand is placed on your heart during recovery if an appropriate cool-down is used following the exercise.

Due to the fact that this is a specialized training program, total workout time is not displayed during the program. The interval time is displayed in the time window instead. It takes only 20 minutes to complete the SPRINT 8 workout.

USING THE CUSTOM USER PROGRAMS

The CUSTOM USER program allows five separate workouts to be completed, saved, and then stored for future use.

Setup for the CUSTOM USER programs begins just as any other program. The user will press the CUSTOM program key.

1. Use the arrows to select one of five CUSTOM USER programs.
2. Press ENTER to select.
3. Set user age, set time, and set weight just as any other program.

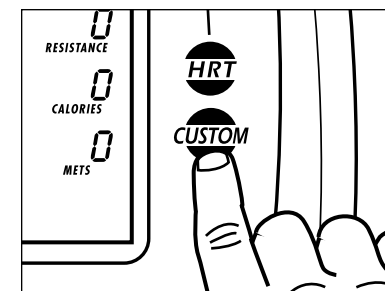

When you have entered your information you will be asked to press START to begin the program and informed that you can adjust resistance as desired to create a new program. As you perform your workout and change your resistance or incline level the CUSTOM USER program will save these changes throughout the program. Your settings will be saved to provide an identical program that can be selected for your next exercise session.

At the end of the program you will be prompted to press ENTER to save.

USING HEART RATE TRAINING

WHAT IS HEART RATE TRAINING?

Heart Rate Training means exercising at an intensity that keeps you in your ideal heart rate zone. Your personal heart rate training zone depends on your fitness goal, such as weight loss, cardiovascular endurance, or strength building. Refer to Page 44 for more information on heart rate training zones. VISION FITNESS HRT® programs are set up to keep you at an ideal heart rate based on your fitness goal. These programs automatically adjust resistance based on your heart rate readings.

The console features three programs (Target HRT, HRT Hill, and HRT Interval) that offer the benefits of Heart Rate Training.

- *These programs use the predicted maximum heart rate formula (220 minus age) to determine your predicted maximum heart rate. Some individuals have higher or lower maximum heart rates than determined by this formula. The programs allow you to modify your Target Heart Rate to achieve your personal goals.*

HAND PULSE HEART RATE SENSORS

The Contact Hand Pulse Sensors are included on each product to monitor your heart rate. To use, grasp the sensors with a comfortable grip during your workout. The console will display your heart rate. Although your signal will be displayed immediately, it may take the system a few seconds to zero in on your actual heart rate.

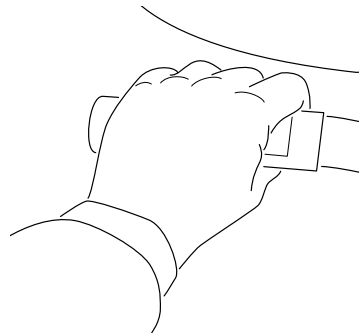

NOTE: The Contact Hand Pulse Sensors will work for the HRT® programs, but it is recommended to use the telemetric chest strap for an uninterrupted signal and ease of use.

TELEMETRIC HEART RATE CHEST STRAP

The wireless Telemetric Chest Strap uses a pair of electrodes on the underside of the strap to send your heart rate signal to the console. Prior to wearing the chest strap, moisten the two rubber electrode pads with several drops of water. These electrodes must remain wet to provide an accurate signal. We advise using the chest strap against your skin, but it also functions through a thin layer of wet clothing.

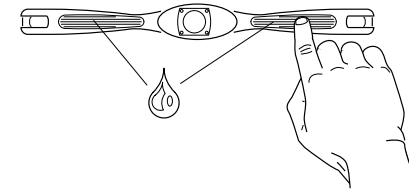

STRAP PLACEMENT

Center the transmitter strap just below the breast or pectoral muscles, directly over your sternum with the logo facing out. Adjust the elastic strap so it is snug but comfortable enough for proper breathing.

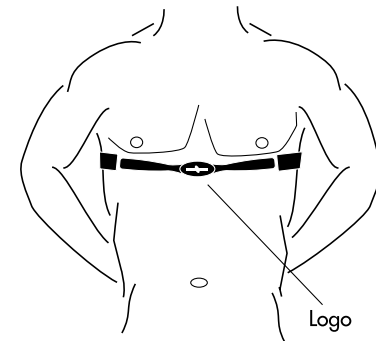

ENGINEERING MODE

Engineering mode consists of 17 optional settings. Use the engineering mode to enable certain features or displays on your console.

ENTERING AND USING ENGINEERING MODE

- Press and hold the UP ▲ and DOWN ▼ resistance keys for approximately three seconds.
- The console will beep and display engineering modes and optional settings. Use the UP ▲ or DOWN ▼ keys to scroll through the options. Press the ENTER key to select the appropriate mode or setting.

OPTIONAL SETTINGS

SETTING	DESCRIPTION
P1 – SET MAX TIME	ALLOWS YOU TO SET THE MAXIMUM TIME A PROGRAM CAN RUN FOR.
P2 – SET USER TIME	ALLOWS YOU TO SET THE TIME THAT THE COMPUTER WILL DEFAULT TO FOR ALL PROGRAMS.
P3 – SET USER AGE	ALLOWS YOU TO SET THE AGE THAT THE COMPUTER WILL DEFAULT TO DURING SETUP.
P4 – SET WEIGHT	ALLOWS YOU TO SET THE WEIGHT THAT THE COMPUTER WILL DEFAULT TO DURING SETUP.
P5 – DEFAULT RESISTANCE LEVEL	ALLOWS YOU TO SET THE RESISTANCE LEVEL THAT THE COMPUTER WILL DEFAULT TO FOR ALL PROGRAMS.
P6 – DEFAULT INCLINE LEVEL	ALLOWS YOU TO SET THE INCLINE LEVEL THAT THE COMPUTER WILL DEFAULT TO FOR ALL PROGRAMS.
P7 – DEFAULT LANGUAGE	ALLOWS YOU TO CHOOSE, FROM THE AVAILABLE LANGUAGES, WHAT LANGUAGE TEXT WILL BE DISPLAYED IN.
P8 – UNIT	ALLOWS YOU TO SET EXERCISE FEEDBACK TO ENGLISH (MILES) OR METRIC (KILOMETERS) SYSTEM.
P9 – ACCUMULATED DATA	ALLOWS YOU TO VIEW THE TOTAL TIME IN HOURS AND TOTAL DISTANCE IN MILES OR KILOMETERS ACCUMULATED ON YOUR PRODUCT.
P10 – DISPLAY TEST	TEST USED BY SERVICE TECHNICIANS TO TEST LCD DISPLAYS.
P11 – HARDWARE TEST	TEST USED BY SERVICE TECHNICIANS TO TEST EDDIE CURRENT BRAKE SYSTEM.
P12 – INCLINE RESET	ALLOWS YOU TO TURN ON OR OFF THE INCLINE RESET AT THE END OF THE WORKOUT.
P13 – INCLINE CALIBRATION	AUTO-CALIBRATION OF ELEVATION MOTOR TO SET MIN, MAX, AND ZERO POSITIONS.
P14 – ADJUST INCLINE	ALLOWS YOU TO ADJUST THE MINIMUM AND MAXIMUM INCLINE LEVELS.
P15 – BEEPER MODE	ALLOWS YOU TO TURN THE BEEPER ON OR OFF.
P16 – SAFETY MODE	ALLOWS YOU TO SET UNIT SO RESISTANCE IS FULLY ENGAGED WHEN NOT IN USE.
P17 – VERSION	ALLOWS SERVICE TECHNICIANS TO VIEW SOFTWARE VERSION USED BY CONSOLE.

- Use the UP ▲ and DOWN ▼ keys within each setting to change the setting.
- Press the ENTER key to save settings.
- To EXIT engineering mode, press and hold the START key for three seconds.

SERVICE AND TROUBLESHOOTING

PREVENTATIVE MAINTENANCE TIPS

- Locate Suspension Elliptical™ Trainer in a cool, dry place.
- Make sure all bolts and fasteners are kept tight.
- Keep the display console free from fingerprints and salt build-up caused by sweat.
- Use a cotton cloth with water and a mild cleaning product to clean the Suspension Elliptical™ Trainer. Other fabrics, including paper towels, may scratch the surface. Do not use ammonia or acid-based cleaners.
- Clean the exterior of the machine thoroughly on a regular basis.

PREVENTATIVE MAINTENANCE SCHEDULE

Follow the schedule below to ensure proper operation of the product.

ITEM	MONTHLY	BI-ANNUALLY
DISPLAY CONSOLE	CLEAN	
ALL BOLTS AND HARDWARE		INSPECT
FRAME	CLEAN	INSPECT
HANDLEBARS	CLEAN	
PLASTIC COVERS	CLEAN	
FOOTPLATES	CLEAN	
POWER CORD		INSPECT

TROUBLESHOOTING

Our Suspension Elliptical™ Trainers are designed to be reliable and easy to use. If, however, you have a problem, these troubleshooting steps may reveal the cause.

PROBLEM: The console does not light up.

SOLUTION: Check to make sure the power switch located on the backside of the console is turned on.

SOLUTION: Make sure the power cord is plugged into the base of the Suspension Elliptical™ Trainer, and the power switch located near the plug is on.

SOLUTION: Make sure the wire harness is plugged into the back of the console.

PROBLEM: You feel a thump or hitch in the stride motion.

SOLUTION: Check assembly and tightness of all hardware.

SOLUTION: Check the bolts and the bracket under the footplate.

NOTE: If the above steps fail to remedy the problem, discontinue use, turn the power off and contact your retailer.

TROUBLESHOOTING YOUR HEART RATE MONITOR CHEST STRAP

PROBLEM: No pulse reading appears.

SOLUTION: There may be a poor connection between the contact pads and skin. Remoisten the contact pads.

SOLUTION: Transmitter is not properly positioned; reposition the chest strap.

SOLUTION: Verify that the distance between the transmitter and receiver is not beyond the recommended range of 36 inches.

PROBLEM: There is an erratic pulse rate.

SOLUTION: Chest strap is too loose; readjust according to directions.

NOTE: It is possible that heart rate monitors will not function properly on some people for a variety of reasons. It may be necessary to experiment with the fit and position of the chest strap. Outside interference sources such as computers, motors, electric dog fences, home security systems, remote controls, CD players, fluorescent lights, etc., may cause problems for heart rate monitors.

LIMITED HOME USE WARRANTY*

VISION FITNESS extends the following exclusive, limited warranty, which shall apply only to the use of the device in the home, for residential, non-commercial purposes only. Any other use of the device shall void this warranty.

VISION FITNESS hereby extends the following limited warranties for the following components of the device, for the time period indicated:

FRAME – LIFETIME VISION FITNESS warrants the Frame against defects in workmanship and materials for the life of the product, so long as it remains in the possession of the original owner.

ECB BRAKE – LIFETIME VISION FITNESS warrants the ECB Magnetic Brake against defects in workmanship and materials for the life of the product, so long as it remains in the possession of the original owner. Only the Brake and Magnet assembly, and no other ancillary components or parts, are covered by this lifetime warranty.

ELECTRONICS & PARTS – FIVE YEARS VISION FITNESS warrants the Electronic components and all original Parts (other than the ECB Magnetic Brake) against defects in workmanship and materials for a period of five years from the date of original purchase, so long as the device remains in the possession of the original owner.

LABOR – ONE YEAR VISION FITNESS shall cover the Labor cost for the repair of the device for a period of one year from the date of original purchase, so long as the device remains in the possession of the original owner.

*This warranty is valid only within limited territories. Please contact with your dealer for local warranty policy.

LIMITED HOME USE WARRANTY (continued)

EXCLUSIVE REMEDY

The exclusive remedy for any of the above warranties shall be repair or replacement of defective Parts, or the supply of Labor to cure any defect, provided that Labor shall be limited to one year. All Labor shall be supplied by the local Retailer who sold the Product, and the Product must be located within that Retailer's service area. Products located outside the Retailer's service area will not be covered by the Labor warranty.

EXCLUSIONS AND LIMITATIONS

This warranty applies only to the original owner and is not transferable. This warranty is expressly limited to the repair or replacement of a defective Frame, ECB Magnetic Brake, Electronic component, or defective Part and is the sole remedy of the warranty. The warranty does not cover normal wear and tear, improper assembly or maintenance, or installation of parts or accessories not originally intended or compatible with the Fitness Product as sold. The warranty does not apply to damage or failure due to accident, abuse, corrosion, discoloration of paint or plastic, or neglect. VISION FITNESS shall not be responsible for incidental or consequential damages. Parts and Electronic components reconditioned to As New Condition by VISION FITNESS or its vendors may sometimes be supplied as warranty replacement parts and constitute fulfillment of warranty terms. Any warranty replacement parts shall be warranted for the remainder of the original warranty term.

VISION FITNESS expressly disclaims all other warranties, express or implied, including but not limited to all warranties of fitness for a particular purpose or of merchantability. This warranty gives you specific legal rights, and your rights may vary from state to state.

WARRANTY REGISTRATION

Your warranty card must be completed and sent to VISION FITNESS before a warranty claim can be processed. You may also register via our website at www.visionfitness.com. Inside the enclosed warranty card, you will find a customer survey. Your care in completing the survey will be of value to us in serving you in the future. Comments and suggestions are always welcome. We are certain you will enjoy your new Suspension Elliptical™ Trainer. Thank you for selecting a VISION FITNESS product.

DEVELOPING A FITNESS PROGRAM

By purchasing this piece of VISION FITNESS exercise equipment, you have made a commitment to exercise and now have the convenience of exercising in your own home. Your new equipment offers the flexibility to exercise at whatever time suits you best. It will be easier to maintain a consistent exercise program that will help you achieve your fitness goals.

ACHIEVING YOUR FITNESS GOALS

An important step in developing a long-term fitness program is to determine your goals. Is your primary goal to lose weight? Improve muscle tone? Relieve stress? Prepare for the spring racing schedule? Knowing what your goals are will help you develop a more successful exercise program. If possible, try to define your personal goals in precise, measurable terms over specific periods of time. Examples of these goals might include:

- Decrease your waistline by two inches over the next two months.
- Run the local 5K race this summer.
- Get 30 minutes of cardiovascular exercise at least five days per week.
- Improve your race time by two minutes over the next year.
- Move from walking a mile to jogging a mile within the next three months.

The more specific the goal, the easier it will be to track your progress. If your goals are long-term, divide them into monthly and weekly segments. Long-term goals can lose some of the motivational benefits. Short-term goals are easier to achieve and will allow you to see the progress you are making. Every time you reach a goal, it is important to set a new goal. This will lead to a healthier lifestyle and will provide the motivation that you will need to move forward.

TRACK YOUR PROGRESS

Now that you have set your exercise goals, it is time to write them down and make an exercise schedule that will help you achieve them. By keeping a fitness diary, you will stay motivated and know where you are in terms of reaching your goals. As time goes on, you will be able to look back with pride to see how far you've come. For your convenience, we have included exercise log sheets in the wellness tools section of our website at www.visionfitness.com.

EXERCISE GUIDELINES

EXERCISE DURATION

A common question asked is, "how much exercise do I need?" We recommend following the guidelines set up by the American College of Sports Medicine (ACSM) for healthy aerobic activity.

- Exercise three to five days per week.
- Warm up for five to 10 minutes before aerobic activity.
- Maintain your exercise activity for 30 to 45 minutes.
- Gradually decrease the intensity of your workout, then stretch to cool down during the last five to 10 minutes.

If weight loss is a major goal, participate in your aerobic activity at least 30 minutes for five days each week.

EXERCISE INTENSITY

The next question asked is, "how hard do I need to work out?" To reap the most cardiovascular benefits from your workout, it is necessary to exercise within a recommended intensity range. We recommend monitoring your exercise heart rate to measure exercise intensity.

TARGET HEART RATE

Target Heart Rate is a percentage of your maximum heart rate. Target Heart Rate will vary for each individual depending on age, current level of conditioning, and personal fitness goals. Exercise heart rate should range from 55% to 85% of your maximum heart rate. As a point of reference, we use the predicted maximum heart rate formula of (220 minus age) to determine your heart rate training zone. Please use the following chart to determine your predicted Target Heart Rate.

		TARGET HEART RATE ZONES Beats Per Minute 									
85%		178	170	161	153	144	136	127	119	110	102
75%		157	150	142	135	127	120	112	105	97	90
65%		136	130	123	117	110	104	97	91	84	78
55%		115	110	104	99	93	88	82	77	71	66
Percentage of Maximum Heart Rate											
AGE		10	20	30	40	50	60	70	80	90	100

EXAMPLE:

If you are a 30-year-old, your predicted maximum heart rate is 190 based on the (220 minus age) formula.

$$220 - 30 = 190$$

Based on the chart above, your heart rate training zone is 104 to 161, which is 55%–85% of 190.

BALANCED FITNESS

While cardiovascular exercise has been the primary method of fitness for many programs over the years, it should not be the only method. Strength Training and Flexibility Training have become more popular as exercise has developed. Incorporating Strength and Flexibility Training into your current exercise program will give you the balance you need to improve your athletic performance, reduce susceptibility to injury, increase metabolic rate, increase bone density, and reach your goals faster.

STRENGTH TRAINING

Strength Training was once known as an activity performed by young males only. That has changed with the advances in scientific research on Strength Training over the last 20 years or so. Research has proven that, after age 30, we begin to lose muscle mass if we do not incorporate Strength Training into our exercise program. With this decrease in muscle mass, our ability to burn calories decreases, our physical ability to do work decreases and our susceptibility to injuries increases. The good news is that, with a proper Strength Training program, we can maintain or even build muscle as we age. A proper Strength Training program will work the muscle groups of the upper and lower body. There are now many options available for Strength Training including: yoga, Pilates, selectorized machines, free weights, stability balls or medicine balls, exercise tubing and body weight exercises, just to name a few.

Recommendations for a minimum Strength Training program include:

FREQUENCY: Two to three days per week

VOLUME: One to three sets consisting of eight to 12 repetitions.

accessible

smooth

versatile

*it all
starts
with a
vision*



toll free 800.335.4348 ■ www.visionfitness.com

© 2009 Vision Fitness. All Rights Reserved. ECB-Plus, HRT, PerfectStride, Quick-Set, Quiet-Glide, SPRINT 8, and Suspension Elliptical are Trademarks of Vision Fitness. May be covered by one or more patents or patents pending; US 5540637, US 5573480, US 5813949, US 5924962, US 5938567, US 6135927, US 6149551, TW 364373, TW 371899, CN 99808486.7

2.09
OM18.76PRD
REVZ